

F.R.L.
F.R.
F (Filtr)
R (Reg)
L (Lub)
Drain Separ
Mech Press SW
Res press exh valve
SlowStart
Anti-bac/Bac-remove Filtr
Film Resist FR
Oil-ProhR
Med Press FR
No Cu/PTFE FRL
Outdrs FRL
Adapter Joiner Press Gauge
CompFRL
LgFRL
PrecsR
VacF/R
Clean FR
ElecPneuR
AirBoost
Speed Ctrl
Silncr
CheckV/other
Fit/Tube
Nozzle
Air Unit
PrecsCompn
Electro Press SW
ContactSW
AirSens
PresSW Cool
Air Flo Sens/Ctrl
WaterRtSens
TotAirSys (Total Air)
TotAirSys (Gamma)
Gas generator
RefrDry
DesicDry
HiPolymDry
MainFiltr
Dischrg etc
Ending

Names of display/operation section

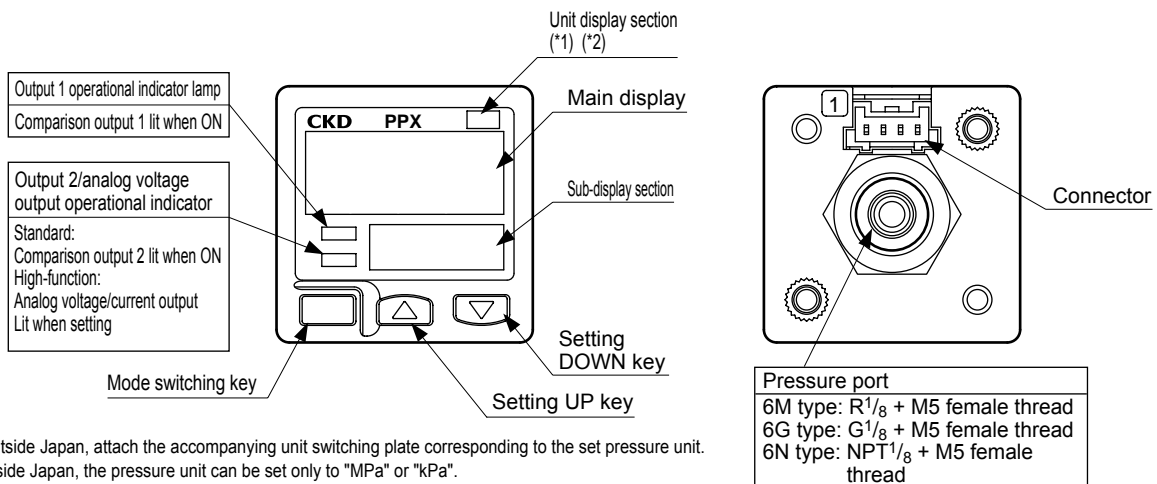

(*1): For outside Japan, attach the accompanying unit switching plate corresponding to the set pressure unit.
(*2): For inside Japan, the pressure unit can be set only to "MPa" or "kPa".

Operation mode and output operation

- The selectable output modes include EASY mode, hysteresis mode, or window comparator mode for comparison output 1 and comparison output 2.
Refer to "Menu setting mode" (page 1164), switch output 1/2 output mode setting, for details.

EASY mode

- This mode is used to turn comparison output ON or OFF.

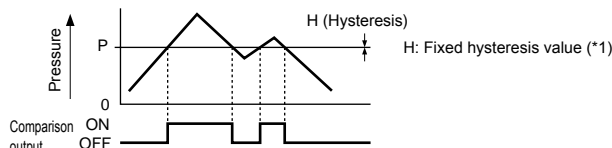

- (*1): Hysteresis can be set to eight stages.
Refer to "PRO mode" (page 1167), [Changing fixed hysteresis] for details on setting.
(*2): In case of comparison output 1, "P-1", or in case of comparison output 2, "P-2" are displayed on the sub-display section.

Hysteresis mode

- In this mode, the comparison output hysteresis is randomly set to control the ON and OFF settings.

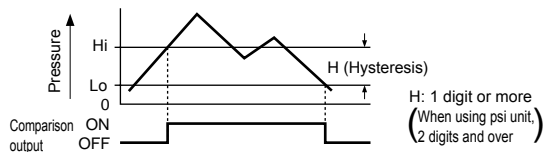

- (*1): In case of comparison output 1, "Hi-1", "Lo-1", or in case of comparison output 2, "Hi-2", "Lo-2" are displayed on the sub-display section.

Window comparator mode

- This mode is used to turn comparison output ON or OFF within the setting range.

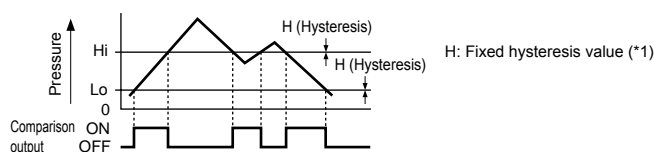

- (*1): Hysteresis can be set to eight stages.
Refer to "PRO mode" (page 1167), [Changing fixed hysteresis] for details on setting.
(*2): In case of comparison output 1, "Hi-1", "Lo-1", or in case of comparison output 2, "Hi-2", "Lo-2" are displayed on the sub-display section.
(*3): Set the setting intervals at Lo side and Hi side to the hysteresis fixed value and over.

About RUN Mode

Threshold setting

- Refer to “Menu setting mode”, [Comparison output 1/2 output mode setting], [Analog voltage/current output/external input switching] for setting method of setting conditions.
- Threshold setting is performed on the sub-display section. The main display section is not switched.

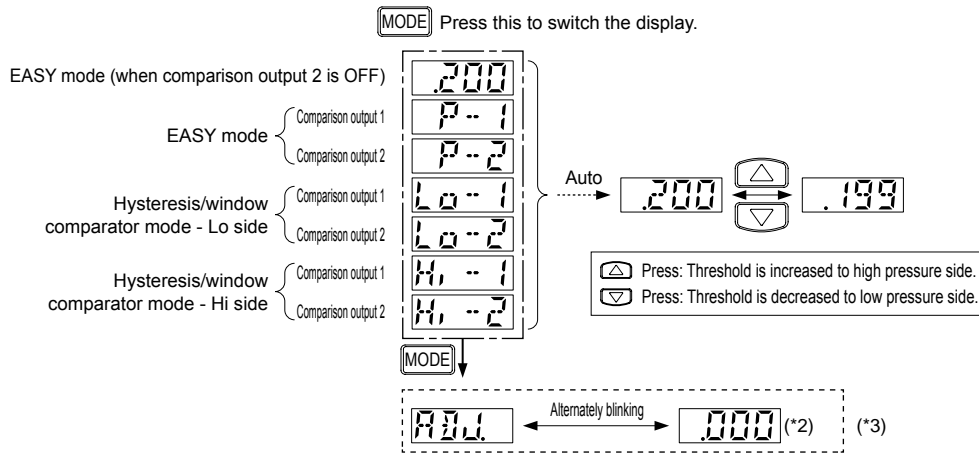

- (*1): When pressure exceeding the set pressure range is applied, “UP” (exceeding the upper limit) or “DOWN” (exceeding the lower limit) is displayed by lighting on the sub-display section.
In addition, “DOWN” is displayed when the threshold at Hi side falls below the threshold at Lo side at the time of threshold setting of “Hysteresis/window comparator mode”.
- (*2): Auto-reference and remote zero adjusting value are shown.
Refer to “Auto reference function” or “Remote zero adjusting function” for details.
- (*3): The area inside the broken line is not displayed unless either “ZERO” or “REF” is set when switching the external input.
Refer to “Menu setting mode”, analog voltage/current output/external input switching, for setting method.

Zero adjustment

- The zero adjustment function forcibly sets the pressure display to “zero” when the pressure port is released to atmospheric pressure.

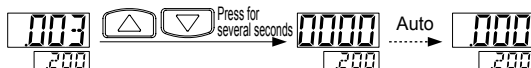

Key lock function

- The key lock function disables key operations so that conditions set for setting modes cannot be mistakenly changed.

[Setting key lock]

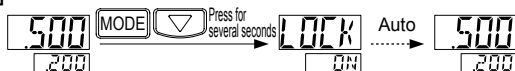

[Releasing key lock]

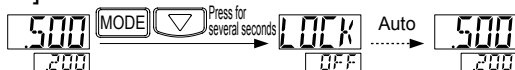

Peak/bottom hold function

- The peak and bottom hold function is to display the peak and bottom values of varying pressure.
- The peak value is displayed on the main display, and the bottom value is displayed on the sub-display section.
- The value at the high pressure side is the peak value, and the value at the low pressure side is the lowest value.

[Setting peak/bottom hold]



[Releasing peak/bottom hold]



F.R.L.
F.R.
F (Filtr)
R (Reg)
L (Lub)
Drain Separ
Mech Press SW
Res press exh valve
SlowStart
Anti-bac/Bac-remove Filtr
Film Resist FR
Oil-ProhR
Med Press FR
No Cu/ PTFE FRL
Outdrs FRL
Adapter Joiner Press Gauge
CompFRL
LgFRL
PrecsR
VacF/R
Clean FR
ElecPneuR
AirBoost
Speed Ctrl
Silncr
CheckV/ other
Fit/Tube
Nozzle
Air Unit
PresCompn
Electro Press SW
ContactSW
AirSens
PresSW Cool
Air Flo Sens/Ctrl
WaterRISens
TotAirSys (Total Air)
TotAirSys (Gamma)
Gas generator
RefrDry
DesicDry
HiPolymDry
MainFiltr
Dischrg etc
Ending

F.R.L.
F.R.
F (Filtr)
R (Reg)
L (Lub)
Drain Separ
Mech Press SW
Res press exh valve
SlowStart
Anti-bac/Bac-remove Filtr
Film Resist FR
Oil-Prohr
Med Press FR
No Cu/ PTFE FRL
Outdrs FRL
Adapter Joiner Press Gauge
CompFRL
LgFRL
PrecsR
VacF/R
Clean FR
ElecPneUR
AirBoost
Speed Ctrl
Silncr
CheckV/ other
Fit/Tube
Nozzle
Air Unit
PrecsCompn
Electro Press SW
ContactSW
AirSens
PresSW Cool
Air Flo Sens/Ctrl
WaterRiSens
TotAirSys (Total Air)
TotAirSys (Gamma)
Gas generator
RefrDry
DesicDry
HiPolymDry
MainFiltr
Dischrg etc
Ending

Menu setting mode

● If the mode select key is held down during setting, the RUN mode is initiated. At this time, the changed settings will come into effect.

RUN Mode

↓ [MODE] Hold down for 2 seconds

[Setting comparison output 1 output mode]

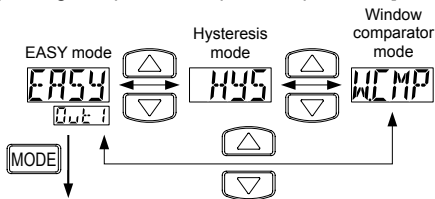

● Standard

[Setting comparison output 2 output mode] (*1)

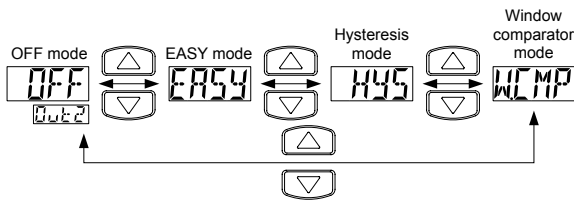

● High-function

[Switching analog voltage output/external input]

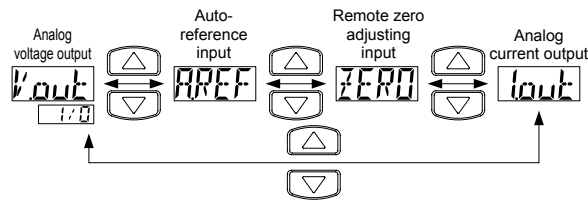

● Standard

[Switching N.O./N.C] (*1)

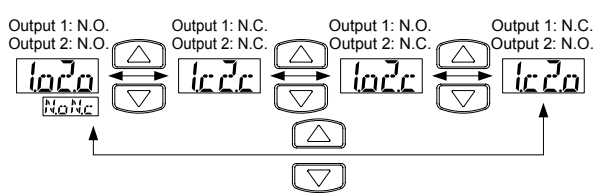

● High-function

[Switching N.O./N.C]

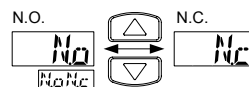

↓ [MODE]

[Setting response time]

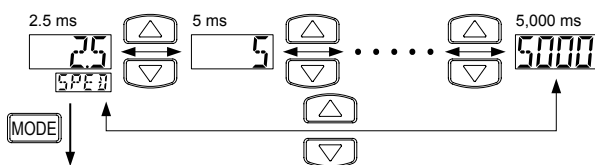

[Switching main display section display color]

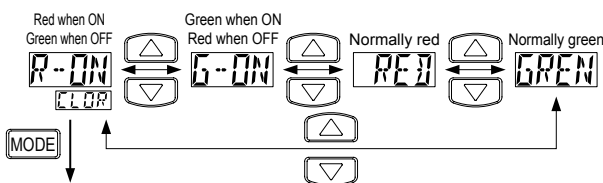

[Unit switching] (*2)

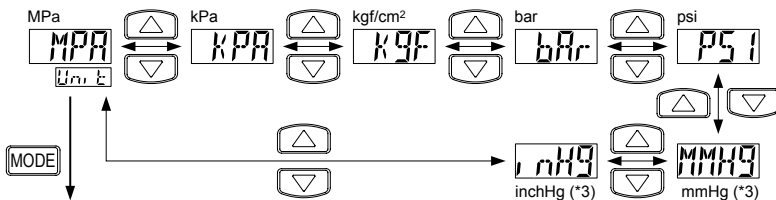

RUN Mode

(*1): If the comparison output 2 output mode setting is set to "OFF", the display at NO/NC changeover is the same as for the high-function.

(*2): For inside Japan, the pressure unit can be set only to "MPa" or "kPa". For the low pressure, the setting descriptions of unit switching are not displayed.

(*3): For the high pressure, they are not displayed.

Setting items	Initial state	Description
Setting comparison output 1 output mode		Set comparison output 1 output mode.
Setting comparison output 2 output mode (only standard)		Set comparison output 2 output mode.
Switching analog voltage output/ external input (only high-function)		The item can be selected from analog voltage output, automatic reference input, or remote zero adjustment input.
Switching NO/NC	Low pressure High pressure 	Set normally open (NO) or normally closed (NC).
Setting response time		Set the response time. Response time can be selected from 2.5 ms, 5 ms, 10 ms, 25 ms, 50 ms, 100 ms, 250 ms, 500 ms, 1000 ms, or 5000 ms.
Switching main display section display color		Colors on the main display can be changed.
Unit switching	Low pressure High pressure 	The pressure unit can be changed.

* NO/NC operation

NO	For EASY mode & HYS mode	For WCMP mode
	Switch is turned ON when the pressure reaches or exceeds the set value.	Switch is turned ON when the pressure is within the set value.
NC	For EASY mode & HYS mode	For WCMP mode
	Switch is turned ON when the pressure reaches or falls below the set value.	Switch is turned OFF when the pressure is within the set value.

- F.R.L.
- F.R.
- F (Filtr)
- R (Reg)
- L (Lub)
- Drain Separ
- Mech Press SW
- Res press exh valve
- SlowStart
- Anti-bac/Bac-remove Filtr
- Film Resist FR
- Oil-ProhR
- Med Press FR
- No Cu/ PTFE FRL
- Outdrs FRL
- Adapter Joiner
- Press Gauge
- CompFRL
- LgFRL
- PrecsR
- VacF/R
- Clean FR
- ElecPneuR
- AirBoost
- Speed Ctrl
- Silncr
- CheckV/ other
- Fit/Tube
- Nozzle
- Air Unit
- PrecsCompn
- Electro Press SW
- ContactSW
- AirSens
- PresSW Cool
- Air Flo Sens/Ctrl
- WaterRISens
- TotAirSys (Total Air)
- TotAirSys (Gamma)
- Gas generator
- RefrDry
- DesicDry
- HiPolymDry
- MainFiltr
- Dischrg etc
- Ending

F.R.L.
F.R.
F (Filtr)
R (Reg)
L (Lub)
Drain Separ
Mech Press SW
Res press exh valve
SlowStart
Anti-bac/Bac-remove Filtr
Film Resist FR
Oil-Prohr
Med Press FR
No Cu/ PTFE FRL
Outdrs FRL
Adapter Joiner
Press Gauge
CompFRL
LgFRL
PrecsR
VacFR
Clean FR
ElecPneUR
AirBoost
Speed Ctrl
Silncr
CheckV/ other
Fit/Tube
Nozzle
Air Unit
PrecsCompn
Electro Press SW
ContactSW
AirSens
PresSW Cool
Air Flo Sens/Ctrl
WaterRtSens
TotAirSys (Total Air)
TotAirSys (Gamma)
Gas generator
RefrDry
DesicDry
HiPolymDry
MainFiltr
Dischrg etc
Ending

PRO mode

- If the mode select key is held down for four seconds during the RUN mode, the PRO mode is initiated.
- If the mode select key is held down during setting, the RUN mode is initiated. At this time, the changed settings will come into effect.
- The display at the left end shows defaults (factory default).

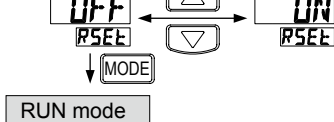
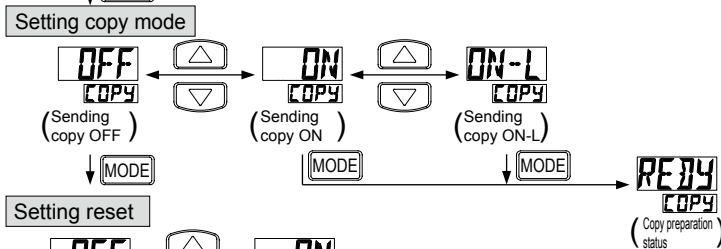
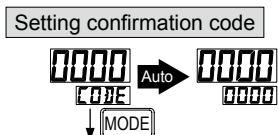
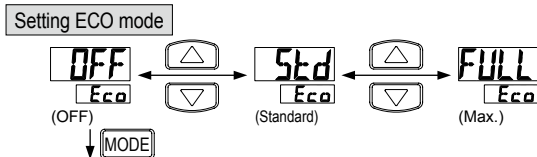
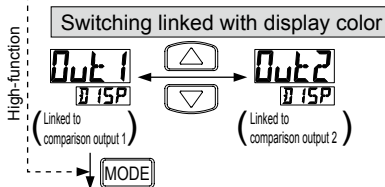
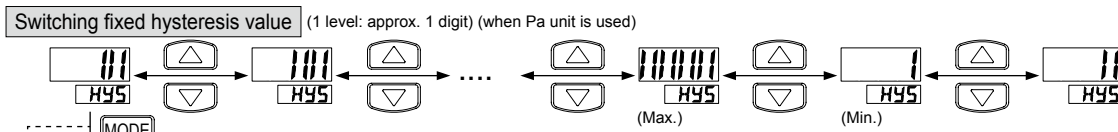
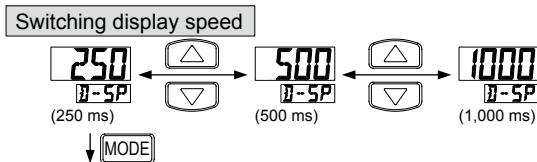
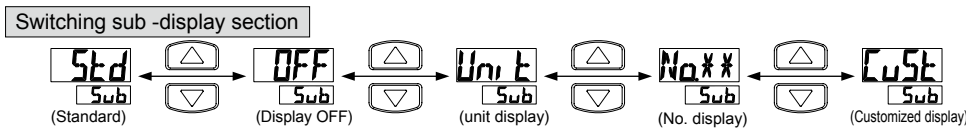
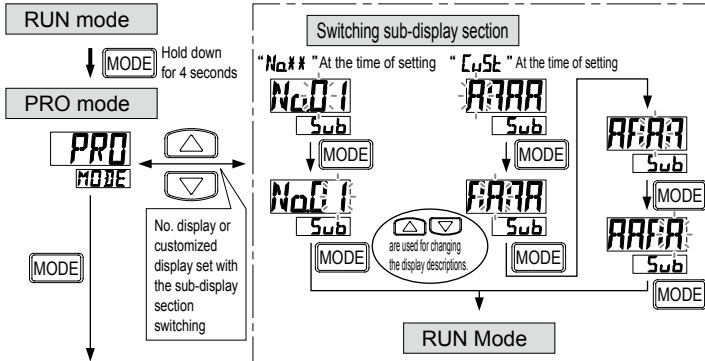

RUN mode

Setting items	Initial state	Description
Switching sub-display section	Std	Set the sub-display section for the RUN mode [0FF]: Nothing is displayed. [Unit]: Displays the current pressure unit. [No**]: Displays a random number. [LU5L]: Displays a random number, alphabetic character (some characters cannot be displayed), and code.
Switching display speed	250	Set the speed of the pressure displayed on the main display.
Switching fixed hysteresis value	01	Set hysteresis for the EASY mode and window comparator mode. (8 stages)
Switching linked with display color (only standard)	00L1	Interlinking the settings made with the main display color switching in the menu setting mode can be done with either comparison output 1 or comparison output 2.
Setting ECO mode	OFF	Power consumption can be reduced. [0FF]: Normal (ECO mode OFF) [5Ld]: Display is dimmed if no key is pressed for 5 seconds in RUN mode. [FUL]: Display is turned OFF if no key is pressed for 5 seconds in RUN mode. The normal display appears temporarily if any key is pressed.
Setting confirmation code	0000	Currently set details can be confirmed. Check codes in the List of Codes.
Setting copy mode	OFF	Details set for the master sensor can be copied to the slave sensor. Refer to "Setting copy function" for details. [0N]: Set details are copied. [0N-L]: Set details are copied and slave side slave sensor keys are locked.
Setting reset	OFF	Settings are returned to defaults. When pressing the mode switching key at the time of "0N", settings are returned to defaults.

Code list

Code	1st digit		2nd digit			3rd digit	4th digit	
	Compare output 1 mode	Switching NO/NC	Standard		High-function type		Main display/color	Display color interlock
			Compare output mode	Switching NO/NC		ANLG V output/ext. input		
0	EASY	NO	OFF	OFF	Analog voltage output	P-1,Lo-1	Red when	Compare output 1
1		NC	EASY	NO	Auto-reference	Hi-1	turned ON	Compare output 2
2	Hysteresis	NO	Hysteresis	NC	Remote zero adjustment	P-2,Lo-2	Green when	Compare output 1
3		NC		NO	Analog current output	Hi-2	turned ON	Compare output 2
4	Window comparator	NO	Window comparator	NC	-	ADJ.	Normally	Compare output 1
5		NC		NO	-	-	red	Compare output 2
6	-	-	-	NC	-	-	Normally	Compare output 1
7	-	-	-	-	-	-	green	Compare output 2

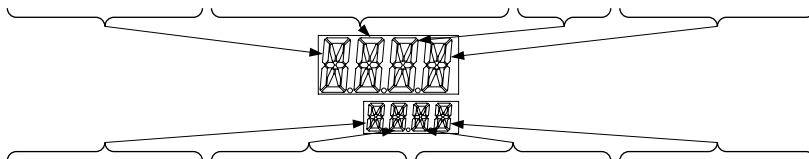

Code	5th digit	6th digit	7th digit	8th digit
	Response time	Unit switching	Display speed	Eco mode
0	2.5 ms	MPa	250 ms	OFF
1	5 ms	kPa	500 ms	Std
2	10 ms	kgf/cm ²	1,000 ms	Full
3	25 ms	bar	-	-
4	50 ms	psi	-	-
5	100 ms	mmHg	-	-
6	250 ms	inchHg	-	-
7	500 ms	-	-	-
8	1,000 ms	-	-	-
9	5,000 ms	-	-	-

Limited to export models with unit select functions.

F.R.L.
F.R.
F (Filtr)
R (Reg)
L (Lub)
Drain Separ
Mech Press SW
Res press exh valve
SlowStart
Anti-bac/Bac-remove Filtr
Film Resist FR
Oil-ProhR
Med Press FR
No Cu/ PTFE FRL
Outdris FRL
Adapter Joiner Press Gauge
CompFRL
LgFRL
PrecsR
VacF/R
Clean FR
ElecPneuR
AirBoost
Speed Ctrl
Silncr
CheckV/ other
Fit/Tube
Nozzle
Air Unit
PrecsCompn
Electro Press SW
ContactSW
AirSens
PresSW Cool
Air Flo Sens/Ctrl
WaterRISens
TotAirSys (Total Air)
TotAirSys (Gamma)
Gas generator
RefrDry
DesicDry
HiPolymDry
MainFiltr
Dischrg etc
Ending

Setting copy function

- This function copies settings from the master sensor to the slave sensor.

- Settings can be copied only between the same models.
Data cannot be copied between different models.
- The setting copy function can copy settings for one master sensor to one slave sensor.

[Installation procedure]

- (1) Set the master sensor setting copy mode to Copy ON or ON-L, and press the mode select key to prepare for copying.
Refer to [Setting copy mode] in "PRO mode" (page 1166), for details.
- (2) Turn master sensor power OFF.
- (3) Connect the master sensor to the slave sensor as shown below.

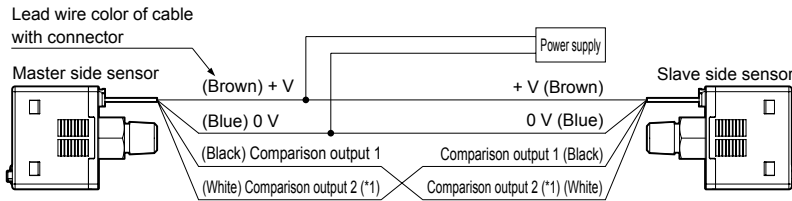

*1: Analog voltage output and external input are connected for the high-function.

- (4) Turn ON the power for the master sensor and slave sensor simultaneously. (*2) (*3)
 - (5) Setting details are encoded in 16-bit code and displayed in orange on the main sensor display, after which copying begins.
 - (6) The same code as in the procedure (5) is displayed in green on the slave sensor's main display, and "k" is displayed on the sub-display section when copying finishes.
 - (7) Turn master sensor and slave sensor power OFF, and disconnect wires.
* To continue copying settings for a different sensor, repeat steps (3) to (6).
- (*2): Set details may not be copied if sensor power is not turned ON simultaneously.
(*3): Pulse output is output to comparison output 1 when power is turned ON.

[Canceling master sensor setting copy mode]

- (1) Turn the master sensor power ON (with slave sensor wiring disconnected).
- (2) Press the mode select key for 2 seconds.

Automatic reference function (high-function only)

- The automatic reference function compensates for the setting using the pressure detected at automatic reference input as the reference pressure.
- Setting value (1)' is automatically compensated for as "setting value (1) + P (a)" using pressure value P (a) detected during automatic reference input as the reference.

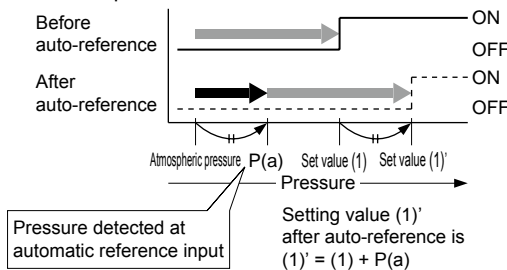

Valid setting range and set pressure range after compensation

- The set pressure range is wider than the rated pressure range to comply with the automatic reference function.

When using automatic reference input, if the compensated setting value exceeds the set pressure, the setting is automatically compensated to within the set pressure range. Check that the set pressure is not exceeded.

Operation chart

[Normal (NO setting for each comparison output)]

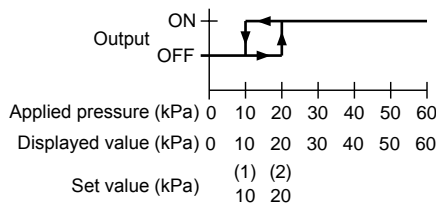

[At auto-reference input
 (NO setting for each comparison output)]

- Detection pressure when auto-reference input: 10 kPa
- Output mode: hysteresis mode

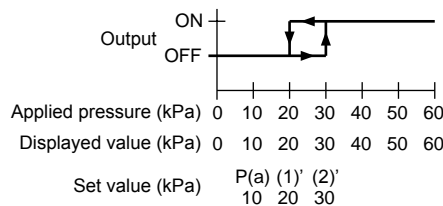

(*1): The setting shifts the same way in EASY and window comparator modes.

- The pressure detected at automatic reference input is set to zero when the setting for the analog voltage output/external input select function is set or power is turned ON again.
- The automatic reference input can be confirmed when the RUN mode threshold is set. Refer to "Threshold setting" in "RUN mode" (page 1163) for details.

Remote zero adjusting (high-function only)

- The remote zero adjustment function forcibly sets the pressure to zero when the external signal is input.

The setting is not compensated for when remote zero adjustment is input. Check that pressure and setting for the remote zero adjustment function do not exceed the set pressure.

Operation chart

[Normal (NO setting for each comparison output)]

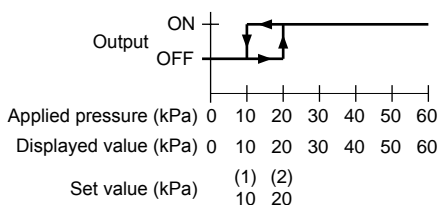

[Pressure for remote zero adjusting input
 (NO setting for each comparison output)]

- Pressure for remote zero adjusting input: 10 kPa
- Output mode: hysteresis mode

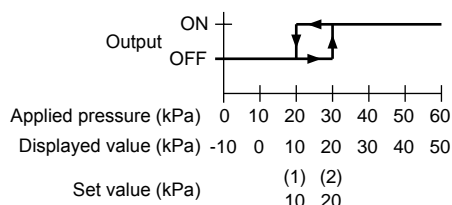

(*1): The setting shifts the same way in EASY and window comparator modes.

- The remote zero adjustment function is cleared to zero when the setting for the analog voltage output/external input select function is set or power is turned ON again, and operation returns to normal using atmospheric pressure as a reference. The remote zero adjustment can be confirmed when the RUN mode threshold is set. Refer to "Threshold setting" in "RUN mode" (page 1163) for details.

Error display

Error display	Description	Treatment
E-1	The load was short-circuited and overcurrent flowed.	Turn power OFF and check the load.
E-3	Pressure was applied during zero point adjustment.	Release pressure applied to the pressure port to atmospheric pressure and adjust the zero point again.
E-4	External input is conducted outside the rated pressure range.	Return applied pressure to within the rated pressure.
E-5	Communication error (disconnection, connection fault, etc.)	When using the copy function, check wiring.
E-6	Communication error (different models)	When using the copy function, confirm that the same models are used.
10 10	Applied pressure exceeds the max. display pressure range.	Return applied pressure to within the rated pressure.
10 10	Applied pressure exceeds the min. (reverse pressure) display pressure range.	

- F.R.L.
- F.R.
- F (Filtr)
- R (Reg)
- L (Lub)
- Drain Separ
- Mech Press SW
- Res press exh valve
- SlowStart
- Anti-bac/Bac-remove Filtr
- Film Resist FR
- Oil-ProhR
- Med Press FR
- No Cu/ PTFE FRL
- Outdrs FRL
- Adapter Joiner
- Press Gauge
- CompFRL
- LgFRL
- PrecsR
- VacF/R
- Clean FR
- ElecPneuR
- AirBoost
- Speed Ctrl
- Silncr
- CheckV/ other
- Fit/Tube
- Nozzle
- Air Unit
- PrecsCompn
- Electro Press SW
- ContactSW
- AirSens
- PresSW Cool
- Air Flo Sens/Ctrl
- WaterRISens
- TotAirSys (Total Air)
- TotAirSys (Gamma)
- Gas generator
- RefrDry
- DesiccDry
- HiPolymDry
- MainFiltr
- Dischrg etc
- Ending

Setting operation example EASY mode

(*1): This is an example of settings from the default when purchased (factory default).

(*2): If setting conditions are unclear, reset the settings in PRO mode, reset to default mode, then start use.

● Suction confirmation

- EASY mode

R01 (-100.0 to 100.0 kPa)

· Mode when powered ON Start from the (RUN mode).

· In a mode other than RUN mode, hold down the "MODE" key and enter the RUN mode.

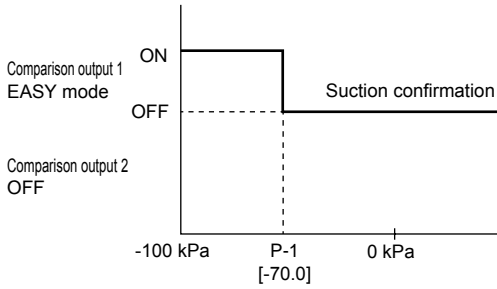

RUN mode screen

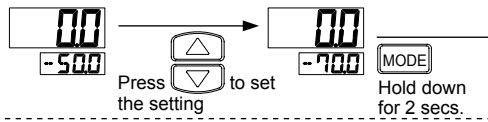

Menu setting mode screen

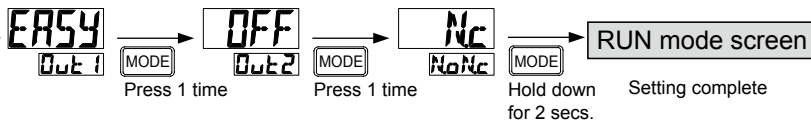

● Suction confirmation + vacuum burst confirmation

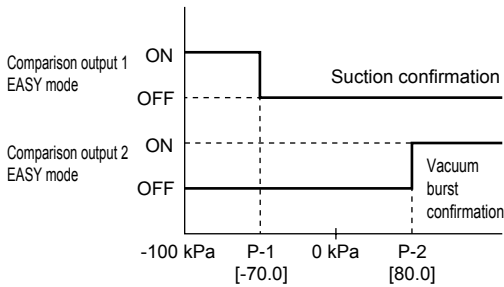

RUN mode screen

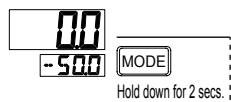

Menu setting mode screen



RUN mode screen

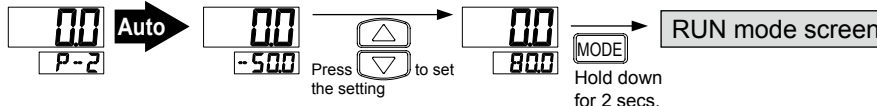
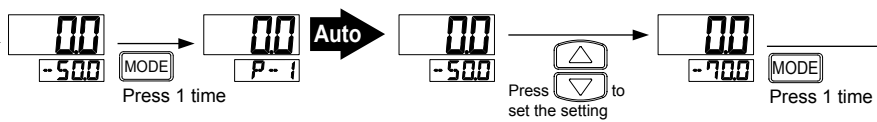

Setting operation example HYS mode (hysteresis mode)

(*1): This is an example of settings from the default when purchased (factory default).
 (*2): If setting conditions are unclear, reset the settings in PRO mode, reset to default mode, then start use.

● Suction confirmation

- HYS mode (hysteresis mode)
- R01 (-100.0 to 100.0 kPa)
- Mode when powered ON Start from the (RUN mode).
- In a mode other than RUN mode, hold down the "MODE" key and enter the RUN mode.

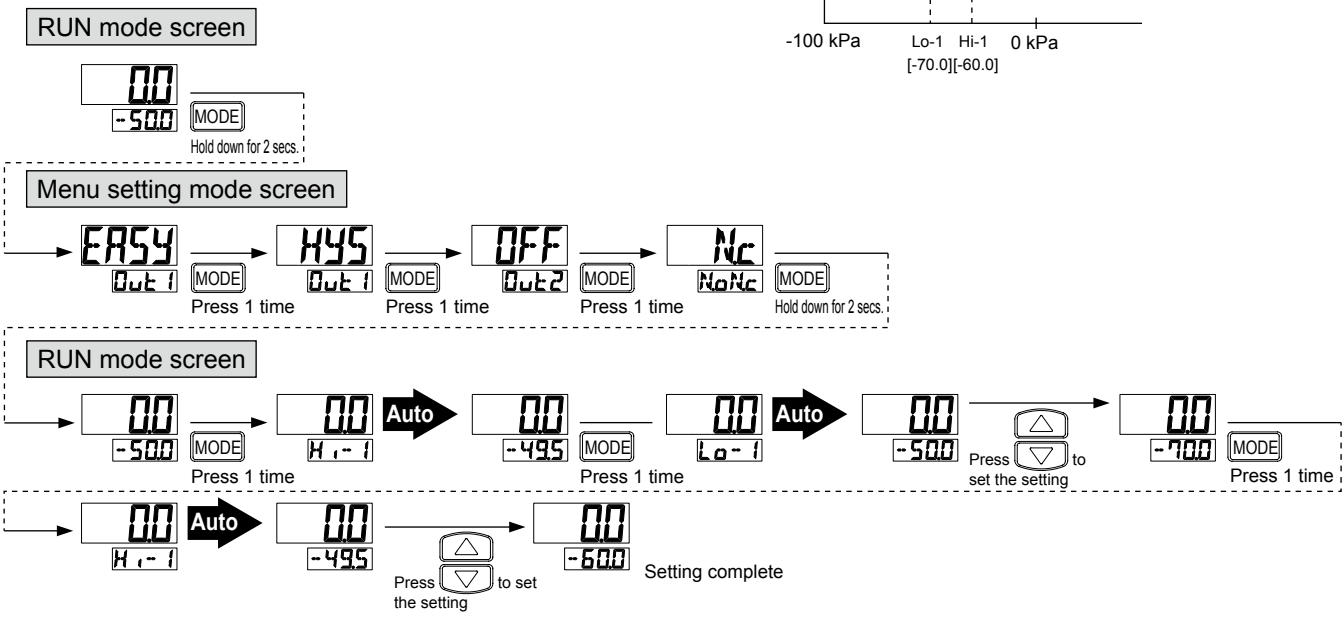
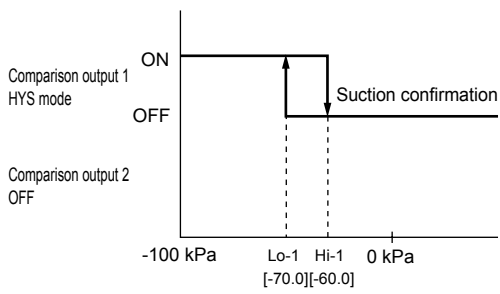

● Suction confirmation + vacuum burst confirmation

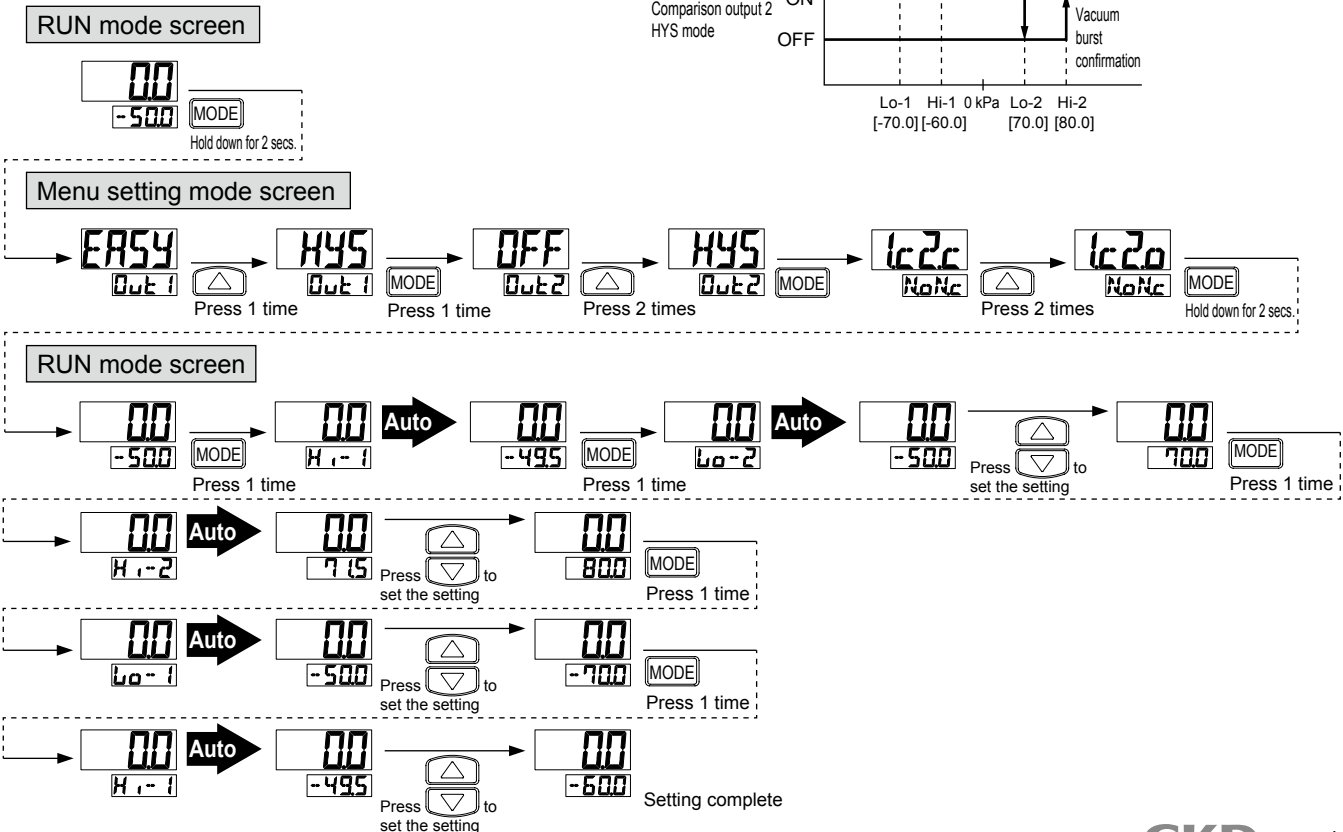
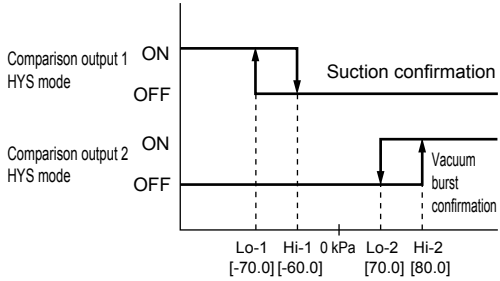

F.R.L.
F.R.
F (Filtr)
R (Reg)
L (Lub)
Drain Separ
Mech Press SW
Res press exh valve
SlowStart
Anti-bac/Bac-remove Filtr
Film Resist FR
Oil-Prohr
Med Press FR
No Cu/ PTFE FRL
Outdris FRL
Adapter Joiner Press Gauge
CompFRL
LgFRL
PrecsR
VacF/R
Clean FR
ElecPneuR
AirBoost
Speed Ctrl
Silncr
CheckV/ other
Fit/Tube
Nozzle
Air Unit
PrecsCompn
Electro Press SW
ContactSW
AirSens
PresSW Cool
Air Flo Sens/Ctrl
WaterRISens
TotAirSys (Total Air)
TotAirSys (Gamma)
Gas generator
RefrDry
DesicDry
HiPolymDry
MainFiltr
Dischrg etc
Ending

Setting operation example WCMP mode (window comparator mode)

(*1): This is an example of settings from the default when purchased (factory default).

(*2): If setting conditions are unclear, reset the settings in PRO mode, reset to default mode, then start use.

● Checking source pressure

- WCMP mode (window comparator mode)

R10 (-0.100 to 1.000 MPa)

· Start from the mode (RUN mode) enabled when power is turned ON.

· In a mode other than RUN mode, hold down the "MODE" key and enter the RUN mode.

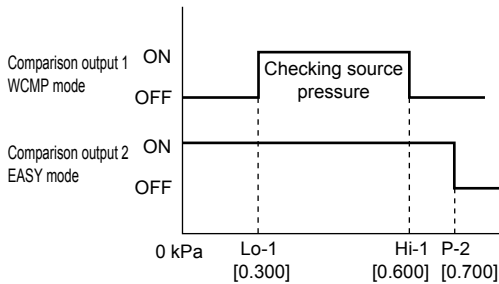

RUN mode screen

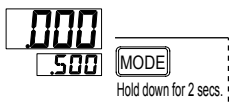

Menu setting mode screen

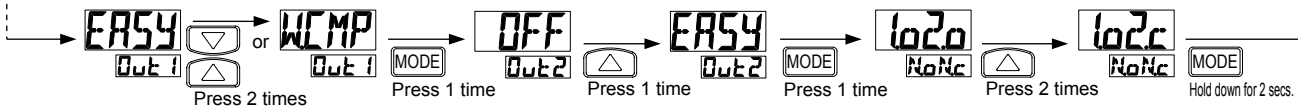

RUN mode screen

