

VSAJ

Suction Cups with 1.5 Bellows Ø 15 to 30 mm

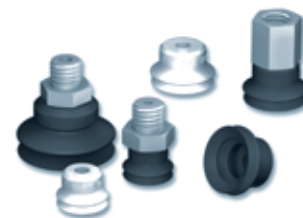

Industry-specific applications

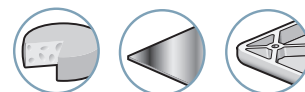

Types of use







2

Materials

NBR Nitrile

SI Translucent silicone

Suction Cup Properties

	Ø (mm)	 (cm ³)	 (lbf) ⁽¹⁾	 (lbf) ⁽¹⁾	 R _{min} (mm)	NBR	SI
VSAJ 15	15	0.5	0.81	0.41	10	VSAJ15NBR	VSAJ15SI
VSAJ 20	20	1.2	1.54	0.76	13	VSAJ20NBR	VSAJ20SI
VSAJ 30	30	3	3.00	1.49	26	VSAJ30NBR	VSAJ30SI

(1) Actual force of the suction cup in use with 65% vacuum and including a safety factor of 2 for horizontal handling and a factor of 4 for vertical handling.

Choice of Fittings

 (Ø)	M5-M	M6-M	M10-M	G1/8"-F	G1/8"-M	G1/4"-F	G1/4"-M
15...20	■	-	-	■	■	-	-
30	-	■	□	■	■	■	■

■ Standard available configurations (suction cup + fitting) refer to page 2/44
 □ Additional mounting configurations see page 2/45

Fitting: M = male F = female

Types of Assembly

COVAL suction cups can be assembled in a wide variety of configurations:

C  **Version C**
Barbed fitting

V  **Version V**
Removable fitting
(adapter and hollow screw)

E  **Version E**
Pressed fitting



Please specify the part n°. e.g. VSAJ20NBRIM18C
Refer to page 2/44

Accessories

To optimize use of your suction cups, Coval offers a comprehensive range of accessories (spring systems, extensions, feeder systems, etc.) see chapters 4 and 14.

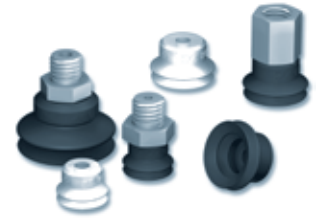

References - "Suction Cup + Fitting"

Ø 15 - 20 mm	C		V			
	THREAD	G1/8"-M	G1/8"-F	M5-M	G1/8"-M	G1/8"-F
VSAJ15NBR	VSAJ15NBRIM18C	VSAJ15NBRIF18C	VSAJ15NBRIMM5V	VSAJ15NBRIM18V	VSAJ15NBRIF18V	
VSAJ15SI	VSAJ15SIIM18C	VSAJ15SIIF18C	VSAJ15SIIMM5V	VSAJ15SIIM18V	VSAJ15SIIF18V	
VSAJ20NBR	-	-	VSAJ20NBRIMM5V	VSAJ20NBRIM18V	VSAJ20NBRIF18V	
VSAJ20SI	-	-	VSAJ20SIIMM5V	VSAJ20SIIM18V	VSAJ20SIIF18V	

Ø 30 mm	E		V				
	THREAD	G1/8"-M	G1/8"-F	M5-M	G1/8"-M	G1/8"-F	G1/4"-M
VSAJ30NBR	VSAJ30NBRIM18	VSAJ30NBRIF18	VSAJ30NBRIMM6V	VSAJ30NBRIM18V	VSAJ30NBRIF18V	VSAJ30NBRIM14V	VSAJ30NBRIF14V
VSAJ30SI	VSAJ30SIIM18	VSAJ30SIIF18	VSAJ30SIIMM6V	VSAJ30SIIM18V	VSAJ30SIIF18V	VSAJ30SIIM14V	VSAJ30SIIF14V

VSAJ 15 -20

VSAJ 30

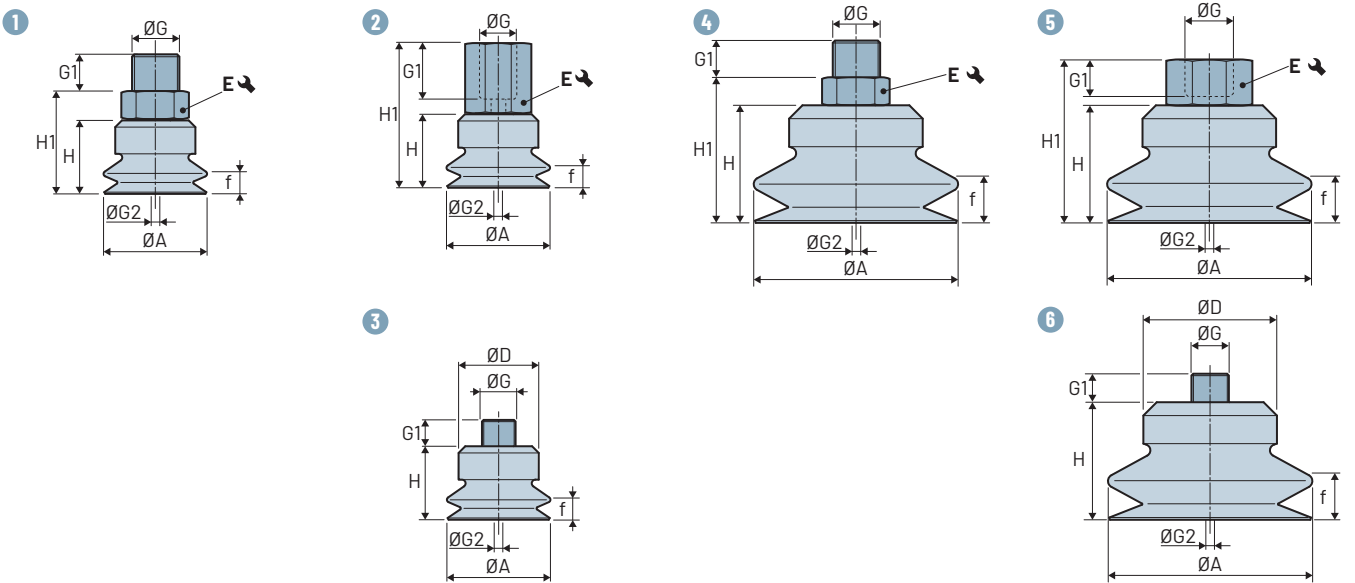

	Diagrams	Ø A	Ø D	f ⁽¹⁾	H	H1	Ø G	G1	Ø G2 ⁽²⁾	E	(g)
Ø 15 - 20 mm	VSAJ15---IM18C	1	15	-	3.3	11	16	8	2.2	14	4.8
	VSAJ15---IF18C	2	15	-	3.3	11	26	9	2.5	14	6
	VSAJ15---IMM5V	3	15	12	3.3	11	-	5	2.5	-	3
	VSAJ15---IM18V	1	15	-	3.3	11	15.5	6	2.5	13	9.4
	VSAJ15---IF18V	2	15	-	3.3	11	24	7.5	2.5	13	12.6
	VSAJ20---IMM5V	3	20	15	5.5	13	-	5	2.5	-	3.8
	VSAJ20---IM18V	1	20	-	5.5	13	17.5	6	2.5	13	10.1
VSAJ20---IF18V	2	20	-	5.5	13	26	7.5	2.5	13	14.6	
Ø 30 mm	VSAJ30---IM18	4	30	-	7	17	42	8	4	14	9
	VSAJ30---IF18	5	30	-	7	17	32	9	4	14	8.4
	VSAJ30---IMM6V	6	30	20	7	17	-	6	3.5	-	7.6
	VSAJ30---IM18V	4	30	-	7	17	21.5	6	3.5	13	14.2
	VSAJ30---IF18V	5	30	-	7	17	30	7.5	3.5	13	17.5
	VSAJ30---IM14V	4	30	-	7	17	21.5	8	3.5	17	20.8
	VSAJ30---IF14V	5	30	-	7	17	33	11	3.5	17	28.1

Note: All dimensions are in mm.

(1) f = Deflection of the suction cup.

(2) Ø G2 = Ø internal orifice of the fitting.

Additional mounting configurations are available (see page 2/45). For standard configurations (suction cup+fitting), the C and V versions are delivered unassembled.

VSAJ

Suction Cups with 1.5 Bellows Ø 15 to 30 mm Assembly Diagrams



2
VSAJ

VSAJ 15 - 20

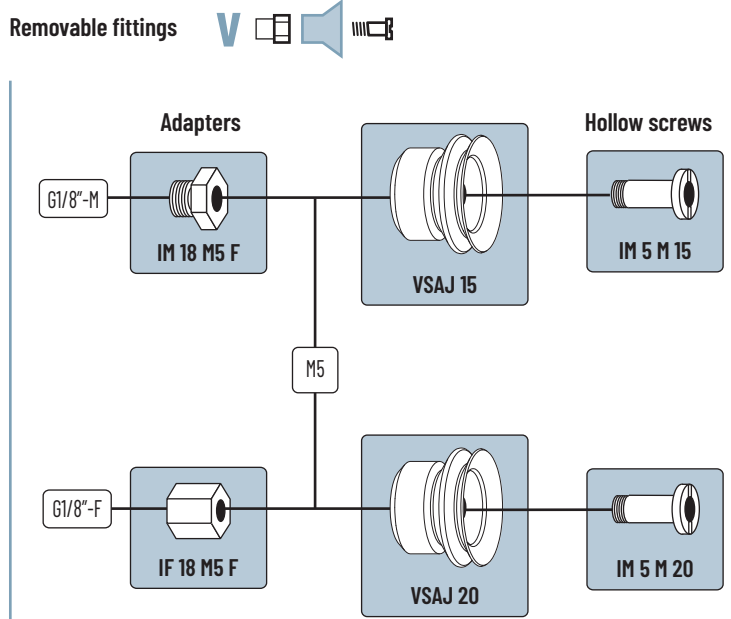
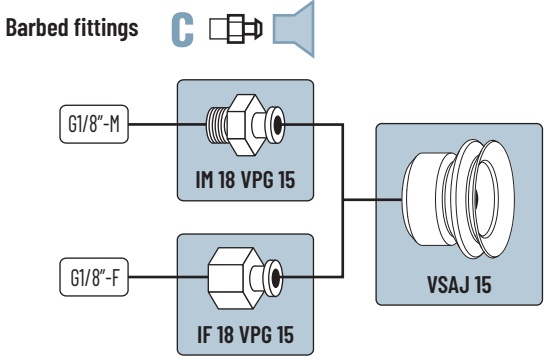

VSAJ 30

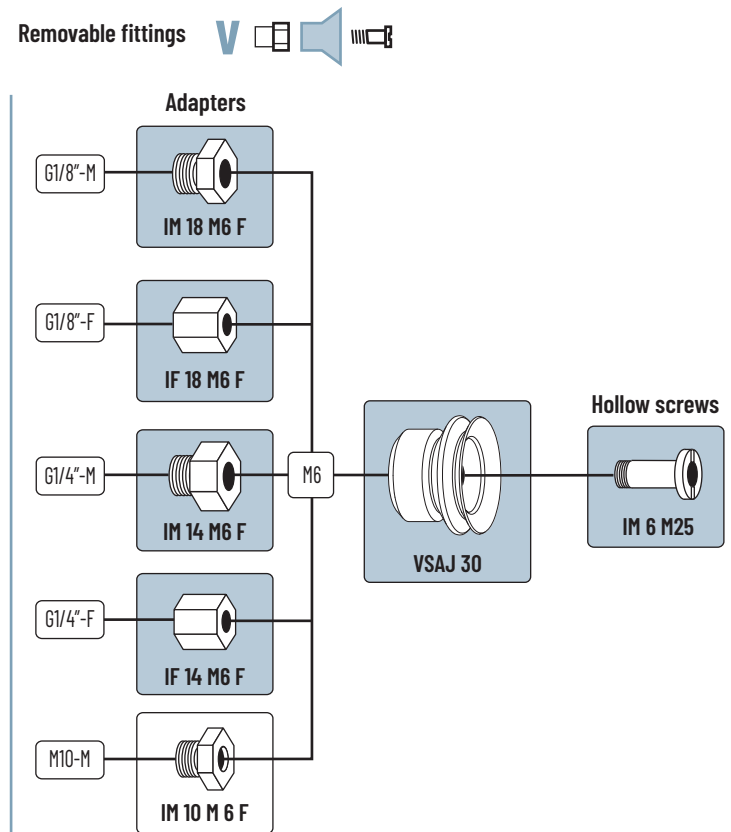
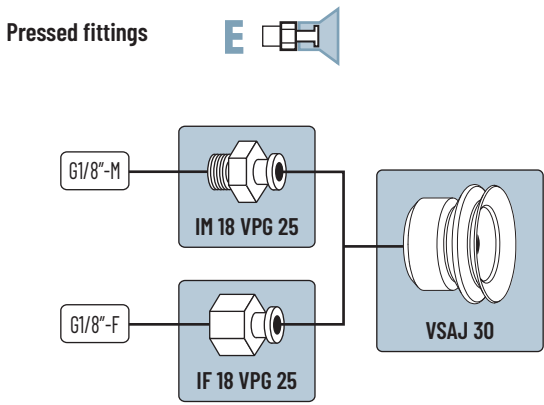

- Configurations (suction cup + fitting) refer to page 2/44
- Non-standard configurations must be ordered in separate part numbers.

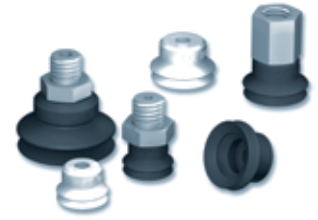

Suction Cups

VSAJ 15

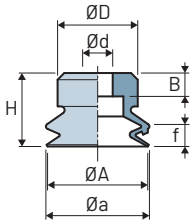

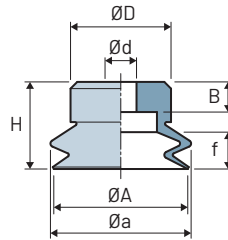

VSAJ 20

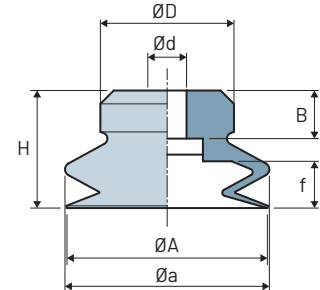

VSAJ 30



	Ø A	H	Ø a	Ø d	Ø D	f ⁽¹⁾	B	 (g)
VSAJ 15	15	11	15.5	4.5	12	3.3	3.5	9
VSAJ 20	20	13	21	4.7	15	5.5	4.5	8.4
VSAJ 30	30	17	30.6	5.8	20	7	7.2	7.6

(1) f = Deflection of the suction cup.

Barbed Fittings

Male - IM

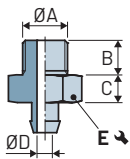

Female - IF

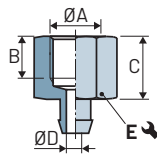

	Ø A	B	C	Ø D	E	Material	 (g)
IM 18 VPG15	G1/8"-M	8	5	2.2	14	Aluminum	4
IF 18 VPG15	G1/8"-F	9	15	2.5	14	Aluminum	5.2

Pressed Fittings

Male - IM

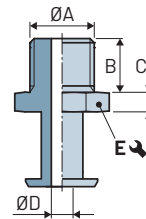

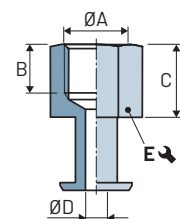

Female - IF

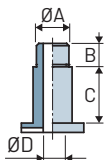

	Ø A	B	C	Ø D	E	Material	 (g)
IM 18 VPG25	G1/8"-M	8	5	4	14	Aluminum	4.08
IF 18 VPG25	G1/8"-F	9	15	4	14	Aluminum	5.5

Hollow Screws



	Ø A	B	C	Ø D	Material	 (g)
IM 5 M15	M5-M	5	2	2.5	Nickel-plated brass	1.3
IM 5 M20	M5-M	5	4	2.5	Nickel-plated brass	2.2
IM 6 M25	M6-M	6	6	3.5	Nickel-plated brass	2.7

Adapters for Hollow Screws

Male - IM

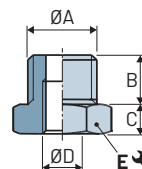

Female - IF

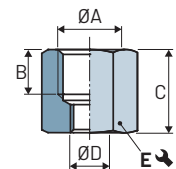

	Ø A	B	C	Ø D	E	Material	 (g)
IM 10 M6F	M10-M	7	3.5	M6-F	13	Brass	5.9
IM 14 M6F	G1/4"-M	8	5	M6-F	17	Nickel-plated brass	15.9
IM 18 M5F	G1/8"-M	6	4.5	M5-F	13	Nickel-plated brass	7.3
IM 18 M6F	G1/8"-M	6	4.5	M6-F	13	Nickel-plated brass	6.6
IF 14 M6F	G1/4"-F	11	16	M6-F	17	Nickel-plated brass	20.5
IF 18 M5F	G1/8"-F	7.5	13	M5-F	13	Nickel-plated brass	10.5
IF 18 M6F	G1/8"-F	7.5	13	M6-F	13	Nickel-plated brass	9.9

The values represent the average characteristics of our products.
Note: All dimensions are in mm.